



# SONOMA FORGE

## RETAIL PRICE LIST

**Effective January 1, 2020**

(Subject to Change without Notice)

[www.sonomaforge.com](http://www.sonomaforge.com)  
[info@sonomaforge.com](mailto:info@sonomaforge.com)  
800-330-5553

# TABLE OF CONTENTS

|   |                                     | <b>PAGE</b> |
|---|-------------------------------------|-------------|
| <b>WATERBRIDGE</b>                      | LAVATORY & TUB FAUCETS              | 4-5         |
|   | TUB FAUCETS WITH HANDSHOWERS        | 6           |
|   | FAUCET ACCESSORIES                  | 7           |
|   | EXPOSED SHOWERS                     | 8-11        |
|   | EXPOSED SHOWER PARTS                | 12-13       |
|   | BATHROOM ACCESSORIES                | 14-15       |
| <b>WHEREVER</b>                         | LAVATORY & TUB FAUCETS              | 16-17       |
|   | FAUCET ACCESSORIES                  | 18          |
|   | CONCEALED SHOWER CONTROLS           | 19          |
|   | CONCEALED SHOWER PARTS              | 20-21       |
| <b>HANDSHOWERS</b>                      | HANDSHOWER KITS                     | 22-23       |
| <b>CIXX</b>                             | FAUCETS & ACCESSORIES               | 24          |
|   | CONCEALED SHOWERS & ACCESSORIES     | 25          |
| <b>STRAP</b>                            | FAUCETS & ACCESSORIES               | 26          |
|   | CONCEALED SHOWER CONTROLS           | 27          |
|   | CONCEALED SHOWER PARTS              | 28-29       |
| <b>SANS HANDS</b>                       | SENSOR FAUCETS                      | 30-31       |
| <b>KITCHEN, BAR, &amp; PREP FAUCETS</b> | BRUT                                | 32-33       |
|   | WATERBRIDGE                         | 34          |
|   | CUVEE & WINGNUT                     | 35          |
|   | BROWNSTONE                          | 36          |
|   | POINT OF USE                        | 37          |
| <b>DRAINS</b>                           | KITCHEN & BAR DRAINS & ACCESSORIES  | 38          |
|   | LAVATORY & BAR DRAINS & ACCESSORIES | 39          |
|   | FLOOR / SHOWER DRAINS               | 40          |
| <b>MISC. PARTS</b>                      | MISCELLANEOUS & REPLACEMENT PARTS   | 41          |
| <b>INDEX</b>                            | PRODUCT INDEX BY MODEL NUMBER       | 42          |
| <b>TERMS &amp; CONDITIONS</b>           | TERMS & CONDITIONS                  | 43          |

**PLEASE VISIT OUR WEBSITE FOR FULL TERMS AND CONDITIONS OF SALE**

# ORDERING SONOMA FORGE PRODUCTS

## INTRODUCTION TO SONOMA FORGE PRODUCT CODES

Sonoma Forge is sold exclusively through a network of authorized showrooms, which can be found on our website. Orders use the following codes, mostly abbreviating the following information: Collection, Application, Spout Style, Size, and Finish.

### COLLECTION

BRUT = Brut  
BS = Brownstone  
CV = Cuvee  
CX = Cixx  
SANS = Sans Hands (sensor faucets)  
ST = Strap  
WB = Waterbridge  
WE = Wherever  
WN = Wingnut

### TYPE

ACC = Accessory  
LAV = Lavatory Faucet  
RTF = Tub Faucet  
SHW = Shower / Shower Accessory

### APPLICATION

DM = Deck Mounted  
FM = Floor Mounted  
WM = Wall Mounted

### SPOUT STYLE

GN = Gooseneck  
CAP = Cap  
FX = Fixed  
LBO = Elbow  
LG = Large Gooseneck  
SQ = Square  
SW = Swiveling  
WF = Waterfall

### SIZE (if applicable)

S = Short  
T = Tall  
L = Long  
LG = Large

### STANDARD FINISH CODES

AB = Antique Bronze (Brownstone Collection)  
B = Brass (CiXX Collection)  
ORB = Oil Rubbed Bronze  
RC = Rustic Copper  
RN = Rustic Nickel  
S = Stainless Steel (CiXX Collection)  
SN = Satin Nickel

## HANDLE & DRAIN OPTIONS

Products in the Waterbridge and Wherever Collections come standard with "Tee" handles.

Cross handles or Offset Lever handles are available at no additional cost when ordered with the fixture. Add any alternate handle preference to your order with the appropriate part number.

Handle prices listed herein are for single replacement handles only.

This also applies to alternate lavatory drains. Most lav faucets include a drain. If a specific drain is preferred, simply note on your original purchase order. Prices listed are for standalone or replacement drains.

Kitchen/Bar and Sensor faucets do not include drains.

## AVAILABILITY

To service your customers better, we attempt to maintain inventory of our most popular product/finish combinations. For availability or lead time, it is most efficient to email Sonoma Forge at: [info@sonomaforge.com](mailto:info@sonomaforge.com)





## SPECIAL ORDER FINISHES & CUSTOM PRODUCTS

Ordering a finish not listed as standard online requires a lead time of approximately 6-8 weeks. There is typically a 10% up charge for special order finishes. Please call or email for actual pricing and lead times.

Custom products normally require a lead time of 8-12 weeks, depending on the product and customization.

Special order and custom products are not returnable.

# WATERBRIDGE COLLECTION

| PHOTO   | DESCRIPTION   | PART NUMBER       | LIST PRICE |
|---|---|-------------------|------------|
|     | <p><b>SHORT DECK MOUNT LAV FAUCET WITH WATERFALL SPOUT</b></p> <p>8" SPREAD, CENTER TO CENTER<br/>2-1/4" SPOUT HEIGHT<br/>7-3/4" CENTER TO TIP</p>  | WB-LAV-DM-WF-S    | \$1690     |
|    | <p><b>TALL DECK MOUNT LAV FAUCET WITH WATERFALL SPOUT</b></p> <p>8" SPREAD, CENTER TO CENTER<br/>6-1/2" SPOUT HEIGHT<br/>7-3/4" CENTER TO TIP</p>   | WB-LAV-DM-WF-T    | \$1690     |
|   | <b>TUB FILLER</b>   | WB-RTF-DM-WF      | \$1990     |
|     | <p><b>WALL MOUNT LAV FAUCET WITH WATERFALL SPOUT</b></p> <p>8" SPREAD, CENTER TO CENTER<br/>10" WALL TO TIP<br/>4" DROP - CENTER TO TIP</p>   | WB-LAV-WM-WF      | \$1890     |
|   | <b>TUB FILLER</b>   | WB-RTF-WM-WF      | \$1990     |
|   | <p><b>FLOOR MOUNT LAV FAUCET WITH WATERFALL SPOUT</b></p> <p>8" SPREAD, CENTER TO CENTER<br/>7-3/4" CENTER TO TIP</p> <p>MADE TO ORDER PER YOUR SPEC,<br/>UP TO 41" TALL TO SPOUT TIP</p> | WB-LAV-FM-WF      | \$2590     |
|   | <b>TUB FILLER w/ 29-1/2" SPOUT HEIGHT</b>   | WB-RTF-FM-WF      | \$2190     |
|   | <b>TUB FILLER w/ SPOUT HEIGHT UP TO 41"</b>   | WB-RTF-FM-WF-CSTM | \$2750     |
|  | <p><b>REMOTE TUB DRAIN &amp; OVERFLOW</b></p> <p>ADJUSTABLE OVERFLOW HEIGHTS<br/>FROM 19" TO 25-1/2"</p> <p>TUB GRID DRAIN INCLUDED</p>   | WB-RTDO           | \$2990     |

# WATERBRIDGE COLLECTION

| PHOTO   | DESCRIPTION  | PART NUMBER        | LIST PRICE |
|---|--|--------------------|------------|
|    | <p>SHORT DECK MOUNT LAV FAUCET WITH ELBOW SPOUT</p> <p>8" SPREAD, CENTER TO CENTER<br/>3-3/4" SPOUT HEIGHT<br/>6-1/2" CENTER TO AERATOR</p>  | WB-LAV-DM-LBO-S    | \$1690     |
|    | <p>TALL DECK MOUNT LAV FAUCET WITH ELBOW SPOUT</p> <p>8" SPREAD, CENTER TO CENTER<br/>6-1/4" SPOUT HEIGHT<br/>6-1/2" CENTER TO AERATOR</p>   | WB-LAV-DM-LBO-T    | \$1690     |
|   | TUB FILLER   | WB-RTF-DM-LBO      | \$1990     |
|    | <p>WALL MOUNT LAV FAUCET WITH ELBOW SPOUT</p> <p>8" SPREAD, CENTER TO CENTER<br/>10" WALL TO TIP<br/>2" DROP - CENTER TO TIP</p>   | WB-LAV-WM-LBO      | \$1890     |
|   | TUB FILLER   | WB-RTF-WM-LBO      | \$1990     |
|  | <p>FLOOR MOUNT LAV FAUCET WITH ELBOW SPOUT</p> <p>8" SPREAD, CENTER TO CENTER<br/>6-1/2" CENTER TO AERATOR</p> <p>MADE TO ORDER PER YOUR SPEC,<br/>UP TO 41" TALL TO SPOUT TIP</p> | WB-LAV-FM-LBO      | \$2590     |
|   | TUB FILLER w/ 29-1/2" SPOUT HEIGHT   | WB-RTF-FM-LBO      | \$2190     |
|   | TUB FILLER w/ SPOUT HEIGHT UP TO 41"   | WB-RTF-FM-LBO-CSTM | \$2750     |

# WATERBRIDGE COLLECTION

| PHOTO | DESCRIPTION | PART NUMBER | LIST PRICE |
|-------|-------------|-------------|------------|
|-------|-------------|-------------|------------|

THESE SYSTEMS ARE MADE TO ORDER, AND MULTIPLE VERSIONS ARE AVAILABLE.  
PLEASE CONTACT SONOMA FORGE FOR MORE INFORMATION.



**DECK MOUNT TUB FILLER  
WITH WATERFALL SPOUT  
AND HANDSHOWER**

**8" SPREAD, CENTER TO CENTER**

**WB-RTF-DM-WF-HS** **\$4550**

**FLOOR MOUNT TUB FILLER  
WITH WATERFALL SPOUT  
AND HANDSHOWER**

**8" SPREAD, CENTER TO CENTER**

**WB-RTF-FM-WF-HS** **\$5050**

IMAGE  
COMING  
SOON

**WALL MOUNT TUB FILLER  
WITH WATERFALL SPOUT  
AND HANDSHOWER**

**8" SPREAD, CENTER TO CENTER**

**WB-RTF-WM-WF-HS** **\$4550**



**DECK MOUNT TUB FILLER (SHOWN)  
WITH ELBOW SPOUT  
AND HANDSHOWER**

**8" SPREAD, CENTER TO CENTER**

**WB-RTF-DM-LBO-HS** **\$4550**

**FLOOR MOUNT TUB FILLER  
WITH ELBOW SPOUT  
AND HANDSHOWER**

**8" SPREAD, CENTER TO CENTER**

**WB-RTF-FM-LBO-HS** **\$5050**

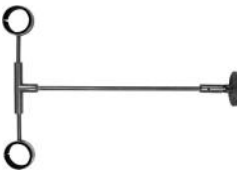







IMAGE  
COMING  
SOON

**WALL MOUNT TUB FILLER  
WITH ELBOW SPOUT  
AND HANDSHOWER**





**8" SPREAD, CENTER TO CENTER**

**WB-RTF-WM-LBO-HS** **\$4550**

# WATERBRIDGE COLLECTION





| PHOTO   | DESCRIPTION   | PART NUMBER     | LIST PRICE |
|---|---|-----------------|------------|
|    | <p><b>RISER EXTENSION KIT<br/>FOR WATERBRIDGE DECK MOUNTED FAUCETS</b></p> <p>ADJUSTABLE FROM 1/2" TO 2-1/2"<br/>SOLD AS PAIR</p>                         | WB-ACC-LEG EXT  | \$175      |
|    | <p><b>OPTIONAL STABILIZER TEE<br/>FOR FLOOR-MOUNTED FAUCETS</b></p> <p>ATTACHES TO WALL, TUB, OR FLOOR<br/>16" CENTER TO END<br/>CAN BE CUT TO LENGTH</p> | WB-ACC-TEE      | \$575      |
|    | <p><b>CLAMP WITH HAND WAND HOOK</b></p> <p>ATTACHES TO TEES AND ELBOWS<br/>OF WATERBRIDGE FIXTURES</p>  | WB-ACC-CLAMP-HS | \$230      |
|   | <p><b>CLAMP WITH SOAP BASKET</b></p> <p>ATTACHES TO TEES AND ELBOWS<br/>OF WATERBRIDGE FIXTURES</p>   | WB-ACC-CLAMP-SD | \$475      |
|  | <p><b>2-HOLE DECK PLATE WITH 8" SPREAD<br/>11" X 3" OVERALL</b></p>   | WB-ACC-DM-PLT   | \$350      |
|  | <p><b>2-HOLE WALL PLATE WITH 8" SPREAD<br/>11" X 3" OVERALL</b></p>   | WB-ACC-WM-PLT   | \$350      |
|  | <p><b>4" REPLACEMENT "T"<br/>HANDLE &amp; STEM</b></p>  | WB-HNDL-T       | \$85       |
|  | <p><b>4" REPLACEMENT OFFSET LEVER<br/>HANDLE &amp; STEM</b></p>   | WB-HNDL-L       | \$85       |
|  | <p><b>3-1/2" REPLACEMENT CROSS<br/>HANDLE &amp; STEM</b></p>  | WE-HNDL-C       | \$85       |

# WATERBRIDGE EXPOSED SHOWERS





| PHOTO  | DESCRIPTION  | PART NUMBER | LIST PRICE |
|--|--|-------------|------------|
|    | <p>MODEL 840<br/>WITH 8" RAINHEAD</p> <p>8" SPREAD, CENTER-TO-CENTER</p> <p>INCLUDES REMOTE<br/>ANTI-SCALD MIXING VALVE</p> <p>SEE PAGE 12-13 FOR MORE OPTIONS</p>                                 | WB-SHW-840  | \$3500     |
|   | <p>MODEL 850<br/>WITH 8" RAINHEAD AND HANDSHOWER</p> <p>8" SPREAD, CENTER-TO-CENTER</p> <p>INCLUDES REMOTE<br/>ANTI-SCALD MIXING VALVE</p> <p>SEE PAGE 12-13 FOR MORE OPTIONS</p>                  | WB-SHW-850  | \$4700     |
|  | <p>MODEL 870<br/>WITH 8" RAINHEAD AND TUB FILLER</p> <p>8" SPREAD, CENTER-TO-CENTER</p> <p>INCLUDES REMOTE<br/>ANTI-SCALD MIXING VALVE</p> <p>SEE PAGE 12-13 FOR MORE OPTIONS</p>                  | WB-SHW-870  | \$4900     |
|  | <p>MODEL 880<br/>WITH 8" RAINHEAD, HANDSHOWER,<br/>AND TUB FILLER</p> <p>8" SPREAD, CENTER-TO-CENTER</p> <p>INCLUDES REMOTE<br/>ANTI-SCALD MIXING VALVE</p> <p>SEE PAGE 12-13 FOR MORE OPTIONS</p> | WB-SHW-880  | \$5700     |







# WATERBRIDGE EXPOSED SHOWERS

| PHOTO   | DESCRIPTION   | PART NUMBER               | LIST PRICE           |
|---|---|---------------------------|----------------------|
|    | <p><b>MODEL 1040<br/>WITH 8" RAINHEAD</b></p> <p><b>10" SPREAD, CENTER-TO-CENTER</b></p> <p><b>INCLUDES REMOTE<br/>ANTI-SCALD MIXING VALVE</b></p> <p><b>SEE PAGE 12-13 FOR MORE OPTIONS</b></p>                          | <p><b>WB-SHW-1040</b></p> | <p><b>\$5100</b></p> |
|   | <p><b>MODEL 1050<br/>WITH 8" RAINHEAD AND HANDSHOWER</b></p> <p><b>10" SPREAD, CENTER-TO-CENTER</b></p> <p><b>INCLUDES REMOTE<br/>ANTI-SCALD MIXING VALVE</b></p> <p><b>SEE PAGE 12-13 FOR MORE OPTIONS</b></p>           | <p><b>WB-SHW-1050</b></p> | <p><b>\$6300</b></p> |
|  | <p><b>MODEL 1070<br/>8" RAINHEAD &amp; FOOTWASH</b></p> <p><b>10" SPREAD, CENTER-TO-CENTER</b></p> <p><b>INCLUDES REMOTE<br/>ANTI-SCALD MIXING VALVE</b></p> <p><b>SEE PAGE 12-13 FOR MORE OPTIONS</b></p>                | <p><b>WB-SHW-1070</b></p> | <p><b>\$6500</b></p> |
|  | <p><b>MODEL 1080<br/>8" RAINHEAD, HANDSHOWER,<br/>AND FOOTWASH</b></p> <p><b>10" SPREAD, CENTER-TO-CENTER</b></p> <p><b>INCLUDES REMOTE<br/>ANTI-SCALD MIXING VALVE</b></p> <p><b>SEE PAGE 12-13 FOR MORE OPTIONS</b></p> | <p><b>WB-SHW-1080</b></p> | <p><b>\$7300</b></p> |







# WATERBRIDGE EXPOSED SHOWERS

| PHOTO   | DESCRIPTION  | PART NUMBER | LIST PRICE |
|---|--|-------------|------------|
|     | <p>MODEL 940 THERMOSTATIC SYSTEM<br/>WITH 8" RAINHEAD</p> <p>10-3/4" SPREAD, CENTER-TO-CENTER</p> <p>SEE PAGE 12-13 FOR MORE OPTIONS</p>                                 | WB-SHW-940  | \$5400     |
|    | <p>MODEL 950 THERMOSTATIC SYSTEM<br/>WITH 8" RAINHEAD AND HANDSHOWER</p> <p>10-3/4" SPREAD, CENTER-TO-CENTER</p> <p>SEE PAGE 12-13 FOR MORE OPTIONS</p>                  | WB-SHW-950  | \$6600     |
|   | <p>MODEL 970 THERMOSTATIC SYSTEM<br/>WITH 8" RAINHEAD AND TUB FILLER</p> <p>10-3/4" SPREAD, CENTER-TO-CENTER</p> <p>SEE PAGE 12-13 FOR MORE OPTIONS</p>                  | WB-SHW-970  | \$6800     |
|  | <p>MODEL 980 THERMOSTATIC SYSTEM<br/>WITH 8" RAINHEAD, HANDSHOWER,<br/>AND TUB FILLER</p> <p>10-3/4" SPREAD, CENTER-TO-CENTER</p> <p>SEE PAGE 12-13 FOR MORE OPTIONS</p> | WB-SHW-980  | \$7600     |

# WATERBRIDGE EXPOSED SHOWERS

| PHOTO   | DESCRIPTION  | PART NUMBER | LIST PRICE |
|---|--|-------------|------------|
|    | <p>MODEL 1140 THERMOSTATIC SYSTEM WITH 8" RAINHEAD</p> <p>10-3/4" SPREAD, CENTER-TO-CENTER</p> <p>SEE PAGE 12-13 FOR MORE OPTIONS</p>                      | WB-SHW-1140 | \$7400     |
|   | <p>MODEL 1150 THERMOSTATIC SYSTEM WITH 8" RAINHEAD AND HANDSHOWER</p> <p>10-3/4" SPREAD, CENTER-TO-CENTER</p> <p>SEE PAGE 12-13 FOR MORE OPTIONS</p>       | WB-SHW-1150 | \$8600     |
|  | <p>MODEL 1170 THERMOSTATIC SYSTEM 8" RAINHEAD &amp; FOOTWASH</p> <p>10-3/4" SPREAD, CENTER-TO-CENTER</p> <p>SEE PAGE 12-13 FOR MORE OPTIONS</p>            | WB-SHW-1170 | \$8800     |
|  | <p>MODEL 1180 THERMOSTATIC SYSTEM 8" RAINHEAD, HANDSHOWER, AND FOOTWASH</p> <p>10-3/4" SPREAD, CENTER-TO-CENTER</p> <p>SEE PAGE 12-13 FOR MORE OPTIONS</p> | WB-SHW-1180 | \$9600     |

# EXPOSED SHOWER PARTS

| PHOTO   | DESCRIPTION  | PART NUMBER                                     | LIST PRICE                             |
|---|--|---|--|
|     | <b>SUPPORT BRACKET FOR WATERBRIDGE EXPOSED SHOWER ARMS</b>   | <b>CEILING MOUNT<br/>(ADJUSTABLE UP TO 17")</b> | <b>WB-SHW-ARM-BRKT-CM</b> <b>\$350</b> |
|   |  | <b>45° WALL MOUNT<br/>(FIXED AT 26" LONG)</b>   | <b>WB-SHW-ARM-BRKT-WM</b> <b>\$350</b> |
|     | <b>WATERBRIDGE SHOWER ARM<br/>3/4" NPT, 1/2" NPS</b><br><br><b>26" ARM REQUIRES<br/>SUPPORT BRACKET</b>  | <b>12"</b>                                      | <b>WB-SHW-ARM12</b> <b>\$450</b>       |
|   |  | <b>18"</b>                                      | <b>WB-SHW-ARM18</b> <b>\$475</b>       |
|   |  | <b>26"</b>                                      | <b>WB-SHW-ARM26</b> <b>\$500</b>       |
|     | <b>45° SHOWER ARM<br/>5" OVERALL LENGTH<br/>3/4" NPT, 1/2" NPS</b><br><br><b>FOR USE WITH WATERBRIDGE EXPOSED SHOWERS,<br/>TO ADAPT PLUNGER-STYLE SHOWER HEADS</b> | <b>WB-SHW-ARM45</b>                             | <b>\$375</b>                           |
|  | <b>HANDSHOWER SLIDEBAR</b><br><br><b>FOR USE WITH WATERBRIDGE EXPOSED SHOWER<br/>SYSTEMS WITH HANDSHOWERS</b>  | <b>HS-WM-SB</b>                                 | <b>\$700</b>                           |
|  | <b>10" EXTENSION<br/>LOWERS TUB SPOUT FOR USE AS FOOTWASH</b><br><br><b>ONLY FOR WATERBRIDGE MODELS 870, 880, 970, &amp; 980</b>                                   | <b>WB-SHW-FTWSH-1</b>                           | <b>\$225</b>                           |
|  | <b>EXTENDED FOOTWASH SPRAY</b><br><br><b>REPLACES TUB SPOUT ON<br/>WATERBRIDGE MODELS 870, 880, 970, &amp; 980</b>   | <b>WB-SHW-FTWSH-2</b>                           | <b>\$375</b>                           |

# EXPOSED SHOWER PARTS

| PHOTO   | DESCRIPTION   | PART NUMBER     | LIST PRICE |
|---|---|-----------------|------------|
|    | PLUNGER STYLE SHOWER HEAD<br>3-1/2" FACE DIAMETER<br>1/2" FIP   | SF-10-060       | \$525      |
|    | 8" SWIVELING RAINHEAD<br>WITH RUBBER JETS<br><br>1/2" FIP   | SF-10-052       | \$750      |
|    | 12" SWIVELING RAINHEAD<br>WITH RUBBER JETS<br><br>3/4" FIP  | SF-10-054       | \$1175     |
|   | SHOWER CURTAIN ROD<br><br>1" OD x 72" LONG MAX<br>2-1/2" O.D. MOUNTING BRACKETS INCLUDED<br><br>SPECIAL ORDER ONLY  | WB-ACC-CR       | \$750      |
|  | SHOWER DOOR HANDLES<br><br>9" ON CENTER - BACK TO BACK  | WB-SHW-HNDL     | \$750      |
|  | CLAMP WITH HAND WAND HOOK<br><br>ATTACHES TO TEES AND ELBOWS<br>OF WATERBRIDGE FIXTURES   | WB-ACC-CLAMP-HS | \$230      |
|  | CLAMP WITH SOAP BASKET<br><br>ATTACHES TO TEES AND ELBOWS<br>OF WATERBRIDGE FIXTURES  | WB-ACC-CLAMP-SD | \$475      |
|  | MOUNTING BRACKET BACKING DISC<br><br>ATTACHES TO BACK OF SHOWER WALL BRACKET,<br>TO SANDWICH GLASS<br><br>*ALSO AVAILABLE FOR ACCESSORIES.<br>PLEASE CONTACT US FOR MORE INFO | WB-SHW-BKG-PLT  | \$215      |







# ACCESSORIES

| PHOTO   | DESCRIPTION                                | PART NUMBER  | LIST PRICE |
|---|--|--------------|------------|
|    | ROBE HOOK                                  | WB-ACC-RH    | \$225      |
|    | 18" TOWEL BAR                              | WB-ACC-TB-18 | \$400      |
|    | 24" TOWEL BAR                              | WB-ACC-TB-24 | \$450      |
|     | 30" TOWEL BAR                              | WB-ACC-TB-30 | \$500      |
| MEASURED IN OVERALL LENGTH  |  |              |            |
|     | PAPER TOWEL HOLDER                         | WB-ACC-TB-11 | \$400      |
|   | TOWEL RING                                 | WB-ACC-TWLR  | \$370      |
|   | WIRE BASKET SOAP DISH<br>(WALL MOUNT ONLY) | WB-ACC-SD    | \$325      |
|   | TOILET PAPER HOLDER                        | WB-ACC-TP-1  | \$400      |
|   | TOILET PAPER HOLDER                        | WB-ACC-TP-2  | \$400      |
|  | MIRROR MOUNT<br>(SOLD INDIVIDUALLY)        | WB-ACC-MIR   | \$135      |

# ACCESSORIES







| PHOTO   | DESCRIPTION  | PART NUMBER              | LIST PRICE |
|---|--|--------------------------|------------|
|    | 2" CABINET KNOB  | WB-ACC-CP                | \$50       |
|    | CABINET PULLS  | 5" WB-ACC-CP5            | \$125      |
|    | MEASURED IN OVERALL LENGTH                               | 10" WB-ACC-CP10          | \$145      |
|    | DECK-MOUNTED SOAP PUMP                                   | WB-ACC-SP-DM             | \$320      |
|   | COUNTERTOP SOAP PUMP<br>INCLUDES BASE RING FOR STABILITY | WB-ACC-SP-CT             | \$550      |
|   | WALL-MOUNTED SOAP PUMP<br>INCLUDES WALL BRACKET          | WB-ACC-SP-WM             | \$550      |
|  | MEASURED CENTER-TO-CENTER                                | 12" GRAB BAR WB-ACC-GB12 | \$405      |
|   |  | 18" GRAB BAR WB-ACC-GB18 | \$425      |
|   |  | 24" GRAB BAR WB-ACC-GB24 | \$450      |
|   |  | 30" GRAB BAR WB-ACC-GB30 | \$480      |
|   |  | 36" GRAB BAR WB-ACC-GB36 | \$515      |
|   |  | 42" GRAB BAR WB-ACC-GB42 | \$550      |
|   |  | 48" GRAB BAR WB-ACC-GB48 | \$585      |

# WHEREVER COLLECTION







| PHOTO  | DESCRIPTION  | PART NUMBER     | LIST PRICE |
|--|--|-----------------|------------|
|    | <p>WIDESPREAD DECK MOUNT LAV FAUCET<br/>WITH FIXED GOOSENECK SPOUT</p> <p>6-1/2" CENTER TO AERATOR<br/>3-1/2" SPOUT HEIGHT</p> | WE-LAV-DM-GN    | \$1890     |
|  | <p>TUB FILLER<br/>*SEE SPEC FOR DIMENSIONS</p>   | WE-RTF-DM-GN    | \$2090     |
|    | <p>WIDESPREAD DECK MOUNT LAV FAUCET<br/>WITH WATERFALL SPOUT</p> <p>7-1/4" CENTER TO TIP<br/>4" SPOUT HEIGHT</p>               | WE-LAV-DM-WF    | \$1890     |
|  | <p>TUB FILLER</p>  | WE-RTF-DM-WF    | \$2090     |
|    | <p>SHORT DECK MOUNT LAV FAUCET<br/>WITH ELBOW SPOUT</p> <p>6" CENTER TO AERATOR<br/>3-1/2" SPOUT HEIGHT</p>                    | WE-LAV-DM-LBO-S | \$1890     |
|  | <p>TUB FILLER</p>  | WE-RTF-DM-LBO-S | \$2090     |
|  | <p>TALL DECK MOUNT LAV FAUCET<br/>WITH ELBOW SPOUT</p> <p>7-1/2" CENTER TO AERATOR<br/>9" SPOUT HEIGHT</p>                     | WE-LAV-DM-LBO-T | \$1890     |
|  | <p>TUB FILLER</p>  | WE-RTF-DM-LBO-T | \$2090     |
|  | <p>SHORT DECK MOUNT LAV FAUCET<br/>WITH CAP SPOUT</p> <p>5-3/8" CENTER TO AERATOR<br/>4-5/8" SPOUT HEIGHT</p>                  | WE-LAV-DM-CAP-S | \$1890     |
|  | <p>TUB FILLER</p>  | WE-RTF-DM-CAP-S | \$2090     |
|  | <p>TALL DECK MOUNT LAV FAUCET<br/>WITH CAP SPOUT</p> <p>7-1/2" CENTER TO AERATOR<br/>10" SPOUT HEIGHT</p>                      | WE-LAV-DM-CAP-T | \$1890     |
|  | <p>TUB FILLER</p>  | WE-RTF-DM-CAP-T | \$2090     |



# WHEREVER COLLECTION

| PHOTO   | DESCRIPTION  | PART NUMBER     | LIST PRICE |
|---|--|-----------------|------------|
|    | <p>WALL MOUNT LAV FAUCET</p> <p>6-3/4" WALL TO AERATOR<br/>3" DROP, CENTER TO TIP</p>                          | WE-LAV-WM-7     | \$1890     |
|   | TUB FILLER   | WE-RTF-WM-7     | \$2090     |
|    | <p>WALL MOUNT LAV FAUCET</p> <p>8-3/4" WALL TO AERATOR<br/>3" DROP, CENTER TO TIP</p>                          | WE-LAV-WM-9     | \$1890     |
|   | TUB FILLER   | WE-RTF-WM-9     | \$2090     |
|    | <p>WALL MOUNT LAV FAUCET<br/>WITH WATERFALL SPOUT</p> <p>7-3/4" WALL TO TIP<br/>2-3/4" DROP, CENTER TO TIP</p> | WE-LAV-WM-WF    | \$1890     |
|   | TUB FILLER   | WE-RTF-WM-WF    | \$2090     |
|   | <p>WALL MOUNT LAV FAUCET<br/>WITH ELBOW SPOUT</p> <p>5-3/4" WALL TO AERATOR<br/>2-1/8" DROP, CENTER TO TIP</p> | WE-LAV-WM-LBO-S | \$1890     |
|   | TUB FILLER   | WE-RTF-WM-LBO-S | \$2090     |
|  | <p>WALL MOUNT LAV FAUCET<br/>WITH ELBOW SPOUT</p> <p>8-1/2" WALL TO AERATOR<br/>2-1/8" DROP, CENTER TO TIP</p> | WE-LAV-WM-LBO-L | \$1890     |
|   | TUB FILLER   | WE-RTF-WM-LBO-L | \$2090     |
|  | <p>WALL MOUNT LAV FAUCET<br/>WITH CAP SPOUT</p> <p>7-5/8" WALL TO AERATOR</p>                                  | WE-LAV-WM-CAP   | \$1890     |
|   | TUB FILLER   | WE-RTF-WM-CAP   | \$2090     |









# WHEREVER COLLECTION

| PHOTO  | DESCRIPTION  |  | PART NUMBER   | LIST PRICE |
|--|--|--|---------------|------------|
|    | 1/2" SINGLE CONTROL<br>WITH PROGRESSIVE VALVE                                    | IN-WALL                                      | WE-WM-SC      | \$1090     |
|  | TWO IN, ONE OUT<br><br>3.5 GPM - FOR USE WITH LAV SPOUT<br>NOT PRESSURE BALANCED | DECK   | WE-DM-SC      | \$1090     |
|    | 1/2" DIVERTER  | IN-WALL<br>1 IN, 2 OUT                       | WE-WM-DIV2    |            |
|  |  | IN-WALL<br>1 IN, 2 OUT<br>W/POSITIVE SHUTOFF | WE-WM-DIV2-SO |            |
|  |  | IN-WALL<br>1 IN, 3 OUT                       | WE-WM-DIV3    | \$775      |
|  |  | IN-WALL<br>1 IN, 3 OUT<br>W/POSITIVE SHUTOFF | WE-WM-DIV3-SO |            |
|  |  | DECK<br>1 IN, 2 OUT                          | WE-DM-DIV2    |            |
|  | 3-1/2" REPLACEMENT "T" HANDLE  |  | WE-HNDL-T     | \$85       |
|  | 3-1/2" REPLACEMENT OFFSET LEVER  |  | WE-HNDL-L     | \$85       |
|  | 3-1/2" REPLACEMENT CROSS HANDLE  |  | WE-HNDL-C     | \$85       |
|  | 1-HOLE PLATE<br>11" X 3" OVERALL   |  | WE-ACC-PLT-1  | \$350      |
|  | 3-HOLE PLATE WITH 8" SPREAD<br>11" X 3" OVERALL                                  |  | WE-ACC-PLT-3  | \$350      |









# WHEREVER COLLECTION

| PHOTO   | DESCRIPTION   | PART NUMBER   | LIST PRICE |
|---|---|---|------------|
|    | PRESSURE BALANCE CONTROL  | 1/2" VALVE<br>7" TRIM PLATE<br>WE-PB                  | \$1550     |
|    | THERMOSTATIC CONTROL  | 3/4" VALVE<br>7" TRIM PLATE<br>WE-THERM               | \$1950     |
|   |   | 1/2" MINI THERM<br>3-3/4" TRIM PLATE<br>WE-MINI-THERM | \$1075     |
|    | IN-WALL VOLUME CONTROL  | 1/2"<br>WE-WM-1/2VC                                   | \$725      |
|   |   | 3/4"<br>WE-WM-3/4VC                                   |            |
|   | IN-WALL 1/2" DIVERTER   | 1 IN, 2 OUT<br>WE-WM-DIV2                             | \$775      |
|   |   | 1 IN, 2 OUT<br>W/POSITIVE SHUTOFF<br>WE-WM-DIV2-SO    |            |
|   |   | 1 IN, 3 OUT<br>WE-WM-DIV3                             |            |
|   |   | 1 IN, 3 OUT<br>W/POSITIVE SHUTOFF<br>WE-WM-DIV3-SO    |            |
|  | WHEREVER WALL MOUNTED WATERFALL TUB SPOUT<br>7-3/4" WALL TO SPOUT TIP<br>2-3/4" DROP, CENTER TO TIP | WE-RTF-WM-WF-SPOUT                                    | \$990      |
|  | WHEREVER WALL MOUNTED 7" TUB SPOUT<br>6-3/4" LONG, WALL TO CENTER<br>3" DROP, CENTER TO TIP         | WE-RTF-WM-7-SPOUT                                     | \$990      |
|  | WHEREVER WALL MOUNTED SHORT ELBOW TUB SPOUT<br>5-3/4" WALL TO AERATOR<br>2-1/8" DROP, CENTER TO TIP | WE-RTF-WM-LBO-S-SPOUT                                 | \$990      |
|  | WATTS REMOTE THERMOSTATIC ANTI-SCALD MIXING VALVE   | SHW-WATTS   | \$275      |



# WHEREVER COLLECTION

| PHOTO   | DESCRIPTION   | PART NUMBER      | LIST PRICE |       |
|---|---|------------------|------------|-------|
|    | LARGE 8-PLUNGER SHOWER HEAD<br>WITH 1/2" x 8" ARM AND WALL FLANGE<br><br>3-1/2" DIAMETER FACE<br>ADJUSTABLE SPRAY | SF-10-105        | \$675      |       |
|     | 8" SWIVELING RAINHEAD<br>WITH RUBBER JETS<br><br>1/2" FIP   | SF-10-052        | \$750      |       |
|     | 12" SWIVELING RAINHEAD<br>WITH RUBBER JETS<br><br>3/4" FIP  | SF-10-054        | \$1175     |       |
|    | FLANGE FOR<br>ARMS AND NECKS  | 1/2" SHOWER ARMS | SF-10-102  | \$55  |
|   |   | 3/4" SHOWER ARMS | SF-10-100  | \$55  |
|  | CEILING MOUNT<br>SHOWER NECKS   | 1/2" x 4"        | SF-10-154  | \$95  |
|   |   | 3/4" x 4"        | SF-10-156  | \$95  |
|   |   | 1/2" x 8"        | SF-10-140  | \$110 |
|   |   | 3/4" x 8"        | SF-10-143  | \$110 |
|   |   | 1/2" x 18"       | SF-10-146  | \$160 |
|   |   | 3/4" x 18"       | SF-10-144  | \$160 |
|   | L-SHAPED<br>SHOWER ARMS   | 1/2" x 12" x 4"  | SF-10-141  | \$100 |
|   |   | 1/2" x 19" x 7"  | SF-10-142  | \$145 |
|   |   | 1/2" x 26" x 6"  | SF-10-103  | \$350 |
|   |   | 3/4" x 26" x 6"  | SF-10-106  | \$375 |
|  | SUPPORT BRACKET<br>FOR 26" ARMS   | 1/2"             | SF-10-150  | \$300 |
|   |   | 3/4"             | SF-10-151  | \$300 |
|  | 1/2" S-SHAPED SHOWER ARM<br><br>RAISES HEAD APPROX. 10" FROM INLET  | SF-10-147        | \$155      |       |







# WHEREVER COLLECTION

| PHOTO   | DESCRIPTION   | PART NUMBER                                 | LIST PRICE                      |
|---|---|---|---------------------------------|
|    | <b>SUPPORT BRACKETS FOR WATERBRIDGE EXPOSED SHOWER ARMS</b>   | <b>CEILING MOUNT (ADJUSTABLE UP TO 17")</b> | <b>WB-SHW-ARM-BRKT-CM \$350</b> |
|   |   | <b>45° WALL MOUNT (FIXED AT 26" LONG)</b>   | <b>WB-SHW-ARM-BRKT-WM \$350</b> |
|    | <b>WATERBRIDGE SHOWER ARM 3/4" NPT, 1/2" NPS</b><br><br><b>26" ARM REQUIRES SUPPORT BRACKET</b>   | <b>12" WB-SHW-ARM12 \$450</b>               |                                 |
|   |   | <b>18" WB-SHW-ARM18 \$475</b>               |                                 |
|   |   | <b>26" WB-SHW-ARM26 \$500</b>               |                                 |
|    | <b>45° SHOWER ARM 5" OVERALL LENGTH 3/4" NPT, 1/2" NPS</b><br><br><b>ALSO USE ON WATERBRIDGE EXPOSED SHOWERS, TO ADAPT PLUNGER-STYLE SHOWER HEADS</b>     | <b>WB-SHW-ARM45 \$375</b>                   |                                 |
|   | <b>SHOWER ARM TRIM RING</b><br><br><b>FOR USE WITH ABOVE SHOWER ARMS AND CONCEALED SHOWER SYSTEMS</b>   | <b>WE-TRIM-RING \$55</b>                    |                                 |
|  | <b>SHOWER CURTAIN ROD</b><br><br><b>1" OD x 72" LONG MAX (CUT DOWN TO LENGTH) 2-1/2" O.D. MOUNTING BRACKETS INCLUDED</b><br><br><b>SPECIAL ORDER ONLY</b> | <b>WB-ACC-CR \$750</b>                      |                                 |
|  | <b>SHOWER DOOR HANDLES</b><br><br><b>9" ON CENTER - BACK TO BACK</b>  | <b>WB-SHW-HNDL \$750</b>                    |                                 |
|  | <b>WALL MOUNT SOAP DISH</b>   | <b>WB-ACC-SD \$325</b>                      |                                 |
|  | <b>BODY SPRAY 1/2" FIP</b>  | <b>SF-10-063 \$295</b>                      |                                 |











# DECK MOUNTED HANDSHOWER KITS

| PHOTO   | DESCRIPTION  | PART NUMBER | LIST PRICE |
|---|--|-------------|------------|
|   | <p>DECK MOUNT HAND SHOWER KIT<br/>WITH WATERBRIDGE STYLE HAND WAND<br/>AND 59" CHROME HOSE</p> | WB-10-276   | \$850      |
|   | <p>DECK MOUNT HAND SHOWER KIT<br/>WITH SMALL-FACED HAND WAND<br/>AND 59" CHROME HOSE</p>       | SF-10-276   | \$700      |
|  | <p>DECK MOUNT HAND SHOWER KIT<br/>WITH LARGE-FACED HAND WAND<br/>AND 59" CHROME HOSE</p>       | SF-10-320   | \$700      |

# WALL MOUNTED HANDSHOWER KITS

| PHOTO   | DESCRIPTION  | PART NUMBER | LIST PRICE |
|---|--|-------------|------------|
|    | WALL-MOUNTED HAND SHOWER KIT WITH WATERBRIDGE STYLE HAND WAND                  | WB-10-255   | \$850      |
|    | WALL-MOUNTED HAND SHOWER KIT WITH SMALL-FACED HAND WAND                        | SF-10-275   | \$700      |
|    | WALL-MOUNTED HAND SHOWER KIT WITH LARGE-FACED HAND WAND                        | SF-10-255   | \$700      |
|   | WALL-MOUNTED HAND SHOWER KIT WITH WATERBRIDGE STYLE HAND WAND AND 24" SLIDEBAR | WB-10-272   | \$1375     |
|  | WALL-MOUNTED HAND SHOWER KIT WITH SMALL-FACED HAND WAND AND 24" SLIDEBAR       | SF-10-272   | \$1250     |
|  | WALL-MOUNTED HAND SHOWER KIT WITH LARGE-FACED HAND WAND AND 24" SLIDEBAR       | SF-10-572   | \$1250     |
|  | 60" REPLACEMENT HOSE FOR WALL-MOUNTED HAND SHOWERS                             | SF-10-015   | \$195      |

# CIXX COLLECTION





| PHOTO   | DESCRIPTION   | PART NUMBER   | LIST PRICE              |
|---|---|---|-------------------------|
|     | DECK MOUNT SHORT LAV FAUCET<br>4-7/8" CENTER TO AERATOR<br>3" SPOUT HEIGHT  | CX-LAV-DM-S   | \$1650                  |
|     | DECK MOUNT TALL LAV FAUCET<br>6-3/4" CENTER TO AERATOR<br>2-1/2" SPOUT HEIGHT   | CX-LAV-DM-T   | \$1800                  |
|     | TUB FILLER  | CX-RTF-DM   | \$1900                  |
|     | WALL MOUNT LAV FAUCET<br>7-1/2" WALL TO AERATOR<br>1-3/4" CENTER TO TIP   | CX-LAV-WM   | \$1650                  |
|     | TUB FILLER  | CX-RTF-WM   | \$1900                  |
|   | 1/2" SINGLE CONTROL<br>WITH PROGRESSIVE VALVE<br>TWO IN, ONE OUT<br>3.5 GPM - FOR USE WITH LAV SPOUT<br>NOT PRESSURE BALANCED | WALL MOUNTED<br>CX-WM-SC<br><br>DECK MOUNTED<br>CX-DM-SC          | \$1150                  |
|  | CABINET KNOB<br>1-1/2" SQUARE   | CX-ACC-CP   | \$70                    |
|   | TOILET PAPER HOLDER<br>10" OVERALL, SINGLE POST STYLE   | CX-ACC-TP   | \$395                   |
|  | ROBE HOOK   | CX-ACC-RH   | \$350                   |
|  | MEASURED INSIDE MOUNTING BRACKETS   | 18"<br>CX-ACC-TB-18<br>24"<br>CX-ACC-TB-24<br>30"<br>CX-ACC-TB-30 | \$425<br>\$450<br>\$475 |





# CIXX COLLECTION

| PHOTO   | DESCRIPTION   | PART NUMBER                   | LIST PRICE       |                  |
|---|---|-------------------------------|------------------|------------------|
|    | SHOWER ARM & HEAD                                     | CX-SHW-HD                     | \$1700           |                  |
|    | 3/4" THERMOSTATIC CONTROL<br>6" SQUARE TRIM PLATE     | CX-THERM                      | \$1850           |                  |
|   | 1/2" PRESSURE BALANCE CONTROL<br>6" SQUARE TRIM PLATE | CX-PB                         | \$1700           |                  |
|    | 1/2" VOLUME CONTROL                                   | CX-WM-1/2VC                   | \$790            |                  |
|   | 3/4" VOLUME CONTROL                                   | CX-WM-3/4VC                   |                  |                  |
|   | IN-WALL 1/2" DIVERTER                                 | 1 IN, 2 OUT                   | CX-WM-DIV2       |                  |
|   | IN-WALL 1/2" DIVERTER                                 | 1 IN, 3 OUT                   | CX-WM-DIV3       | \$875            |
|   | DECK 3/4" DIVERTER                                    | 1 IN, 2 OUT                   | CX-DM-DIV        |                  |
|  | BODY SPRAY WITH SWIVEL HEAD                           | CX-BODY-SPRAY                 | \$500            |                  |
|  | WALL TUB SPOUT  | CX-RTF-WM-SPOUT               | \$890            |                  |
|  | SHOWER DOOR HANDLES                                   | CX-SHW-HNDL                   | \$475            |                  |
|   | BACK-TO-BACK<br>10" BARS, WITH POSTS 6" C-C           |                               |                  |                  |
|  | MIRROR FRAME<br>1-1/2" WIDE FRAME                     | 18" x 24"                     | CX-ACC-MIR-1824  | \$1600           |
|   | DOES NOT INCLUDE GLASS                                | 24" x 30"                     | CX-ACC-MIR-2430  | \$1700           |
|   |   | 24" x 36"                     | CX-ACC-MIR-2436  | \$1800           |
|   |   | MIRROR FRAME<br>3" WIDE FRAME | 18" x 24"        | CX-ACC-MIR-1824W |
|   | DOES NOT INCLUDE GLASS                                | 24" x 30"                     | CX-ACC-MIR-2430W | \$1900           |
|   |   | 24" x 36"                     | CX-ACC-MIR-2436W | \$2000           |



# STRAP COLLECTION

| PHOTO   | DESCRIPTION  | PART NUMBER | LIST PRICE |
|---|--|-------------|------------|
|     | <p>WIDESPREAD DECK MOUNT LAV FAUCET WITH FIXED SPOUT</p> <p>7" CENTER TO AERATOR<br/>3-1/2" SPOUT HEIGHT</p>                               | ST-LAV-DM   | \$975      |
|   | TUB FILLER WITH FIXED SPOUT  | ST-RTF-DM   | \$1350     |
|     | <p>WIDESPREAD WALL MOUNT LAV FAUCET WITH FIXED SPOUT</p> <p>8-3/8" WALL TO AERATOR</p>   | ST-LAV-WM-L | \$1075     |
|   | TUB FILLER WITH FIXED SPOUT  | ST-RTF-WM-L | \$1350     |
|     | <p>WIDESPREAD WALL MOUNT LAV FAUCET WITH FIXED SPOUT</p> <p>5-3/4" WALL TO AERATOR</p>   | ST-LAV-WM-S | \$1075     |
|   | TUB FILLER WITH FIXED SPOUT  | ST-RTF-WM-S | \$1350     |
|  | <p>1/2" SINGLE CONTROL WITH PROGRESSIVE VALVE</p> <p>TWO IN, ONE OUT</p> <p>3.5 GPM - FOR USE WITH LAV SPOUT<br/>NOT PRESSURE BALANCED</p> | ST-SC       | \$750      |







## ACCESSORIES

|   |                     |             |       |
|---|---------------------|-------------|-------|
|   | ROBE HOOK           | ST-ACC-RH   | \$200 |
|   | TOILET PAPER HOLDER | ST-ACC-TP   | \$310 |
|  | 18"                 | ST-ACC-TB18 | \$360 |
|   | 24"                 | ST-ACC-TB24 | \$380 |
|   | 30"                 | ST-ACC-TB30 | \$400 |
| MEASURED BETWEEN ESCUTCHEONS  |                     |             |       |





# STRAP CONCEALED SHOWERS

| PHOTO  | DESCRIPTION  | PART NUMBER | LIST PRICE    |       |
|--|--|-------------|---------------|-------|
|   | <p>PRESSURE BALANCE CONTROL</p> <p>1/2" VALVE<br/>6-3/4" SQUARE TRIM PLATE</p> | ST-PB       | \$1350        |       |
|   | <p>THERMOSTATIC CONTROL</p> <p>3/4" VALVE<br/>6-3/4" SQUARE TRIM PLATE</p>     | ST-THERM    | \$1950        |       |
|  | 1/2" SHUT-OFF  | ST-WM-1/2VC | \$400         |       |
|  | 3/4" SHUT-OFF  | ST-WM-3/4VC |               |       |
|  | 1/2" IN-WALL DIVERTER  | 1 IN, 2 OUT | ST-WM-DIV2    |       |
|  | 1/2" IN-WALL DIVERTER WITH POSITIVE SHUTOFF                                    | 1 IN, 2 OUT | ST-WM-DIV2-SO |       |
|  | 1/2" IN-WALL DIVERTER  | 1 IN, 3 OUT | ST-WM-DIV3    | \$400 |
|  | 1/2" IN-WALL DIVERTER WITH POSITIVE SHUTOFF                                    | 1 IN, 3 OUT | ST-WM-DIV3-SO |       |
|  | 3/4" DECK DIVERTER   | 1 IN, 2 OUT | ST-DM-DIV     |       |







# STRAP CONCEALED SHOWERS

| PHOTO   | DESCRIPTION   | PART NUMBER                                   | LIST PRICE                 |
|---|---|---|----------------------------|
|    | <p>8-PLUNGER SHOWER HEAD<br/>WITH 1/2" x 8" ARM AND SQUARE WALL FLANGE</p> <p>3-1/2" DIAMETER FACE<br/>ADJUSTABLE SPRAY</p> | ST-10-105                                     | \$700                      |
|    | <p>ROUND SWIVELING RAIN HEAD<br/>WITH RUBBER JETS</p> <p>1/2" FIP</p>   | <p>7" SF-10-042</p> <p>12" SF-10-047</p>      | <p>\$600</p> <p>\$1700</p> |
|     | <p>SQUARE SWIVELING RAIN HEAD<br/>WITH RUBBER JETS</p> <p>1/2" FIP</p>  | <p>6" x 7" SF-10-037</p> <p>12" SF-10-088</p> | <p>\$600</p> <p>\$1950</p> |
|    | <p>ROUND BODY SPRAY<br/>WITH SQUARE FLANGE</p> <p>1/2" FIP</p>  | ST-10-124                                     | \$300                      |
|  | <p>WALL-MOUNTED HAND SHOWER KIT<br/>WITH CONTEMPORARY HAND WAND</p>   | ST-10-135                                     | \$950                      |
|  | <p>WALL-MOUNTED HAND SHOWER KIT<br/>WITH CONTEMPORARY HAND WAND<br/>AND 24" SLIDEBAR</p>                                    | ST-18-132                                     | \$1550                     |
|   | <p>DECK MOUNT HAND SHOWER KIT<br/>WITH CONTEMPORARY HAND WAND<br/>AND 59" CHROME HOSE</p>                                   | ST-10-361                                     | \$900                      |

# STRAP CONCEALED SHOWERS

| PHOTO   | DESCRIPTION  |                 | PART NUMBER | LIST PRICE |
|---|--|-----------------|-------------|------------|
|    | SQUARE FLANGE FOR<br>1/2" ARMS AND NECKS                           | FOR 1/2" ARMS   | SF-10-049   | \$95       |
|    | ROUND FLANGE FOR<br>ARMS AND NECKS                                 | FOR 1/2" ARMS   | SF-10-102   | \$55       |
|   |  | FOR 3/4" ARMS   | SF-10-100   | \$55       |
|    | CEILING MOUNT<br>SHOWER NECKS                                      | 1/2" x 4"       | SF-10-154   | \$95       |
|   |  | 3/4" x 4"       | SF-10-156   | \$95       |
|   |  | 1/2" x 8"       | SF-10-140   | \$110      |
|   |  | 3/4" x 8"       | SF-10-143   | \$110      |
|   |  | 1/2" x 18"      | SF-10-146   | \$160      |
|   |  | 3/4" x 18"      | SF-10-144   | \$160      |
|   | L-SHAPED<br>SHOWER ARMS  | 1/2" x 12" x 4" | SF-10-141   | \$100      |
|   |  | 1/2" x 19" x 7" | SF-10-142   | \$145      |
|   |  | 1/2" x 26" x 6" | SF-10-103   | \$350      |
|   |  | 3/4" x 26" x 6" | SF-10-106   | \$375      |
|  | 1/2" S-SHAPED SHOWER ARM<br><br>RAISES HEAD APPROX. 10" FROM INLET |                 | SF-10-147   | \$155      |





# SANS HANDS

| PHOTO  | DESCRIPTION  | PART NUMBER            | LIST PRICE |
|--|--|------------------------|------------|
|    | SANS HANDS WITH WHEREVER DECK MOUNT GOOSENECK SPOUT<br><br>6-1/2" PROJECTION, CENTER TO AERATOR<br>3-1/2" SPOUT HEIGHT     | SANS-WE-DM-GN          | \$1900     |
|    | SANS HANDS WITH WHEREVER DECK MOUNT WATERFALL SPOUT<br><br>7-1/4" PROJECTION, CENTER TO TIP<br>4" SPOUT HEIGHT             | SANS-WE-DM-WF          | \$1900     |
|    | SANS HANDS WITH WHEREVER DECK MOUNT ELBOW SPOUT<br><br>SHORT:<br>6" PROJECTION, CENTER TO AERATOR<br>3-1/2" SPOUT HEIGHT   | SHORT SANS-WE-DM-LBO-S | \$1900     |
|  | TALL:<br>7-1/2" PROJECTION, CENTER TO AERATOR<br>9" SPOUT HEIGHT   | TALL SANS-WE-DM-LBO-T  | \$1900     |
|  | SANS HANDS WITH WHEREVER DECK MOUNT CAP SPOUT<br><br>SHORT:<br>5-3/8" PROJECTION, CENTER TO AERATOR<br>4-5/8" SPOUT HEIGHT | SHORT SANS-WE-DM-CAP-S | \$1900     |
|  | TALL:<br>7-1/2" PROJECTION, CENTER TO AERATOR<br>10" SPOUT HEIGHT  | TALL SANS-WE-DM-CAP-T  | \$1900     |
|  | SANS HANDS WITH CIXX DECK MOUNT SPOUT<br><br>SHORT:<br>4-7/8" PROJECTION, CENTER TO AERATOR<br>3" SPOUT HEIGHT             | SHORT SANS-CX-DM-S     | \$1900     |
|  | TALL:<br>6-3/4" PROJECTION, CENTER TO AERATOR<br>2-1/2" SPOUT HEIGHT   | TALL SANS-CX-DM-T      | \$1900     |
|  | SANS HANDS WITH STRAP DECK MOUNT SPOUT<br><br>7" PROJECTION, CENTER TO AERATOR<br>3-1/2" SPOUT HEIGHT                      | SANS-ST-DM             | \$1900     |
|  | AC ADAPTER / TRANSFORMER (CANNOT BE HARDWIRED)   | SANS-AC-ADAPTER        | \$50       |

# SANS HANDS



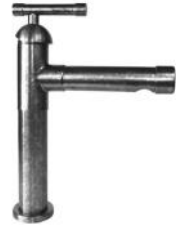
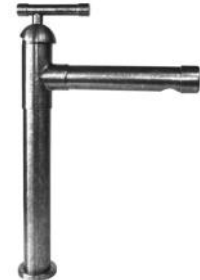

| PHOTO   | DESCRIPTION  | PART NUMBER      | LIST PRICE |
|---|--|------------------|------------|
|    | SANS HANDS WITH WHEREVER WALL MOUNT SPOUT<br>6-3/4" WALL TO AERATOR<br>3" DROP, WALL TO TIP                            | SANS-WE-WM-7     | \$1900     |
|    | SANS HANDS WITH WHEREVER WALL MOUNT SPOUT<br>8-3/4" WALL TO AERATOR<br>3" DROP, WALL TO TIP                            | SANS-WE-WM-9     | \$1900     |
|    | SANS HANDS WITH WHEREVER WALL MOUNT WATERFALL SPOUT<br>7-3/4" WALL TO TIP<br>2-3/4" DROP, CENTER TO TIP                | SANS-WE-WM-WF    | \$1900     |
|   | SANS HANDS WITH WHEREVER WALL MOUNT SHORT ELBOW SPOUT<br>5-3/4" WALL TO AERATOR<br>2-1/8" DROP, CENTER TO AERATOR      | SANS-WE-WM-LBO-S | \$1900     |
|  | SANS HANDS WITH WHEREVER WALL MOUNT LONG ELBOW SPOUT<br>8-1/2" LONG, WALL TO AERATOR<br>2-1/8" DROP, CENTER TO AERATOR | SANS-WE-WM-LBO-L | \$1900     |
|  | SANS HANDS WITH WHEREVER WALL MOUNT CAP SPOUT<br>7-1/8" WALL TO AERATOR  | SANS-WE-WM-CAP   | \$1900     |
|  | SANS HANDS WITH CIXX WALL MOUNT SPOUT<br>7-1/2" WALL TO AERATOR<br>1-3/4" DROP, CENTER TO AERATOR                      | SANS-CX-WM       | \$1900     |
|  | SANS HANDS WITH STRAP WALL MOUNT SPOUT<br>8-1/2" WALL TO AERATOR   | SANS-ST-WM       | \$1900     |
|  | AC ADAPTER / TRANSFORMER<br>(CANNOT BE HARDWIRED)  | SANS-AC-ADAPTER  | \$50       |

# BRUT COLLECTION

| PHOTO  | DESCRIPTION   | PART NUMBER   | LIST PRICE |
|--|---|---------------|------------|
|    | <p>BRUT SHORT LAV FAUCET<br/>WITH FIXED ELBOW SPOUT</p> <p>6-1/2" CENTER TO AERATOR<br/>4" SPOUT HEIGHT</p> | BRUT-LBO-S-FX | \$1650     |
|    | <p>BRUT TALL LAV FAUCET<br/>WITH FIXED ELBOW SPOUT</p> <p>7-1/2" CENTER TO AERATOR<br/>8" SPOUT HEIGHT</p>  | BRUT-LBO-T-FX | \$1650     |
|   | <p>BRUT SHORT LAV FAUCET<br/>WITH FIXED WATERFALL SPOUT</p> <p>7" CENTER TO TIP<br/>2-1/2" SPOUT HEIGHT</p> | BRUT-WF-S-FX  | \$1650     |
|  | <p>BRUT TALL LAV FAUCET<br/>WITH FIXED WATERFALL SPOUT</p> <p>7" CENTER TO TIP<br/>7-1/2" SPOUT HEIGHT</p>  | BRUT-WF-T-FX  | \$1650     |
|  | <p>BRUT SHORT LAV FAUCET<br/>WITH FIXED CAP SPOUT</p> <p>6" CENTER TO AERATOR<br/>4" SPOUT HEIGHT</p>       | BRUT-CAP-S-FX | \$1625     |
|  | <p>BRUT TALL LAV FAUCET<br/>WITH FIXED CAP SPOUT</p> <p>7-1/2" CENTER TO AERATOR<br/>8" SPOUT HEIGHT</p>    | BRUT-CAP-T-FX | \$1625     |









# BRUT COLLECTION

| PHOTO   | DESCRIPTION  | PART NUMBER | LIST PRICE |
|---|--|-------------|------------|
|    | <p>BRUT FAUCET WITH SWIVEL SPOUT AND PULL-OUT SPRAY</p> <p>9-3/4" CENTER-TO-AERATOR<br/>11-1/2" SPOUT HEIGHT</p> | BRUT-PO     | \$1925     |
|    | <p>BRUT FAUCET WITH SWIVEL ELBOW SPOUT</p> <p>7-1/2" CENTER-TO-AERATOR<br/>8-1/2" SPOUT HEIGHT</p>               | BRUT-PREP   | \$1725     |
|   | <p>BRUT FAUCET WITH SWIVEL ELBOW SPOUT</p> <p>8-3/4" CENTER TO AERATOR<br/>8-3/4" SPOUT HEIGHT</p>               | BRUT-LBO-SW | \$1790     |
|  | <p>BRUT KITCHEN FAUCET WITH SWIVEL CAP SPOUT</p> <p>8-3/4" CENTER TO AERATOR<br/>9" SPOUT HEIGHT</p>             | BRUT-CAP-SW | \$1790     |
|  | BRUT SIDE SPRAY  | BRUT-SP     | \$345      |







# KITCHEN & BAR

| PHOTO  | DESCRIPTION  |              | PART NUMBER | LIST PRICE |
|--|--|--------------|-------------|------------|
|    | <b>WATERBRIDGE DECK MOUNT FAUCET WITH SQUARE SPOUT</b><br><br>8" SPREAD, CENTER TO CENTER<br>9-1/2" CENTER TO AERATOR        | FIXED SPOUT  | WB-DM-SQ-FX | \$1875     |
|  |  | SWIVEL SPOUT | WB-DM-SQ-SW | \$1975     |
|    | <b>WATERBRIDGE WALL FAUCET WITH SQUARE SPOUT</b><br><br>8" SPREAD, CENTER TO CENTER<br>9-1/2" SPOUT, CENTER TO AERATOR       | FIXED SPOUT  | WB-WM-SQ-FX | \$1925     |
|  |  | SWIVEL SPOUT | WB-WM-SQ-SW | \$1975     |
|   | <b>WATERBRIDGE DECK FAUCET WITH GOOSENECK SPOUT</b><br><br>8" SPREAD, CENTER TO CENTER<br>6-1/2" CENTER TO AERATOR           | FIXED SPOUT  | WB-DM-GN-FX | \$1875     |
|  |  | SWIVEL SPOUT | WB-DM-GN-SW | \$1975     |
|  | <b>WATERBRIDGE WALL FAUCET WITH GOOSENECK SPOUT</b><br><br>8" SPREAD, CENTER TO CENTER<br>6-1/2" CENTER TO AERATOR           | FIXED SPOUT  | WB-WM-GN-FX | \$1925     |
|  |  | SWIVEL SPOUT | WB-WM-GN-SW | \$1975     |
|  | <b>WATERBRIDGE DECK FAUCET WITH LARGE SWIVEL GOOSENECK SPOUT</b><br><br>8" SPREAD, CENTER TO CENTER<br>11" CENTER TO AERATOR | SWIVEL SPOUT | WB-DM-GN-LG | \$2125     |
|  | <b>WATERBRIDGE WALL FAUCET WITH LARGE GOOSENECK SPOUT</b><br><br>8" SPREAD, CENTER TO CENTER<br>11" CENTER TO AERATOR        | SWIVEL SPOUT | WB-WM-GN-LG | \$2125     |

# KITCHEN & BAR

| PHOTO   | DESCRIPTION  |              | PART NUMBER   | LIST PRICE |
|---|--|--------------|---------------|------------|
|    | CUVÉE DECK MOUNT FAUCET WITH GOOSENECK SPOUT         | FIXED SPOUT  | CV-GN-FX      | \$1150     |
|   | 6-1/2" CENTER TO AERATOR<br>8-1/2" SPOUT HEIGHT      | SWIVEL SPOUT | CV-GN-SW      | \$1300     |
|   | FAUCET WITH SIDE SPRAY                               | SWIVEL SPOUT | CV-GN-W/SP    | \$1600     |
|    | CUVÉE DECK MOUNT FAUCET WITH LARGE GOOSENECK SPOUT   | SWIVEL SPOUT | CV-GN-LG      | \$1400     |
|   | 11" CENTER TO AERATOR<br>8-1/2" SPOUT HEIGHT         |              |               |            |
|   | FAUCET WITH SIDE SPRAY                               |              | CV-GN-LG-W/SP | \$1700     |
|   | WINGNUT DECK MOUNT FAUCET WITH GOOSENECK SPOUT       | FIXED SPOUT  | WN-GN-FX      | \$1150     |
|   | 6-1/2" CENTER TO AERATOR<br>8-1/2" SPOUT HEIGHT      | SWIVEL SPOUT | WN-GN-SW      | \$1300     |
|   | FAUCET WITH SIDE SPRAY                               | SWIVEL SPOUT | WN-GN-W/SP    | \$1600     |
|  | WINGNUT DECK MOUNT FAUCET WITH LARGE GOOSENECK SPOUT | SWIVEL SPOUT | WN-GN-LG      | \$1400     |
|   | 11" CENTER TO AERATOR<br>8-1/2" SPOUT HEIGHT         |              |               |            |
|   | FAUCET WITH SIDE SPRAY                               |              | WN-GN-LG-W/SP | \$1700     |
|  | WINGNUT DECK MOUNT FAUCET WITH SQUARE SPOUT          | FIXED SPOUT  | WN-SQ-FX      | \$1150     |
|   | 9-1/2" CENTER TO AERATOR<br>6" SPOUT HEIGHT          | SWIVEL SPOUT | WN-SQ-SW      | \$1300     |
|   | FAUCET WITH SIDE SPRAY                               | SWIVEL SPOUT | WN-SQ-W/SP    | \$1600     |
|  | WINGNUT SIDE SPRAY                                   |              | WN-SP         | \$345      |

# BROWNSTONE COLLECTION

| PHOTO   | DESCRIPTION  | PART NUMBER   | LIST PRICE |        |
|---|--|---------------|------------|--------|
|    | DECK FAUCET WITH FIXED SPOUT<br>CERAMIC HOT & COLD BUTTONS<br><br>5-1/4" CENTER TO AERATOR<br>9-1/2" HEIGHT, TO SPOUT TIP                      | BS-DM-FX      | \$1300     |        |
|    | DECK FAUCET WITH SWIVEL SPOUT<br>CERAMIC HOT & COLD BUTTONS<br><br>6-1/2" CENTER TO AERATOR<br>9-5/8" HEIGHT, TO SPOUT TIP                     | BS-DM-SW      | \$1500     |        |
|    | DECK FAUCET<br>WITH SWIVEL SPOUT AND SIDE SPRAY<br>CERAMIC HOT & COLD BUTTONS<br><br>6-1/2" CENTER TO AERATOR<br>9-5/8" HEIGHT, TO SPOUT TIP   | BS-DM-SW-W/SP | \$2000     |        |
|   | DECK FAUCET<br>WITH LARGE SWIVEL SPOUT<br>CERAMIC HOT & COLD BUTTONS<br><br>11" CENTER TO AERATOR<br>9" HEIGHT, TO SPOUT TIP                   | BS-DM-LG      | \$1750     |        |
|  | DECK FAUCET<br>WITH LARGE SWIVEL SPOUT AND SIDE<br>SPRAY<br>CERAMIC HOT & COLD BUTTONS<br><br>11" CENTER TO AERATOR<br>9" HEIGHT, TO SPOUT TIP | BS-DM-LG-W/SP | \$2150     |        |
|  | WALL FAUCET<br>WITH FIXED OR SWIVEL SPOUT<br>CERAMIC HOT & COLD BUTTONS<br><br>9-1/8" WALL TO AERATOR<br>6-1/4" SPREAD, CENTER TO CENTER       | FIXED SPOUT   | BS-WM-FX   | \$1400 |
|   |  | SWIVEL SPOUT  | BS-WM-SW   | \$1400 |
|  | WALL FAUCET<br>WITH LARGE SWIVEL SPOUT<br>CERAMIC HOT & COLD BUTTONS<br><br>13-1/2" WALL TO AERATOR<br>6-1/4" SPREAD, CENTER TO CENTER         | BS-WM-LG      | \$1700     |        |





# POINT OF USE FAUCETS

| PHOTO   | DESCRIPTION                               |                             | PART NUMBER | LIST PRICE |
|---|---|-----------------------------|-------------|------------|
|    | POINT OF USE FAUCET WITH ELBOW SPOUT      | HOT & COLD                  | POU-LBO-HC  | \$900      |
|    | POINT OF USE FAUCET WITH ELBOW SPOUT      | COLD ONLY (HANDLE ON RIGHT) | POU-LBO-C   | \$670      |
|   |   | HOT ONLY (HANDLE ON LEFT)   | POU-LBO-H   | \$700      |
|   | POINT OF USE FAUCET WITH GOOSENECK SPOUT  |                             | POU-GN-HC   | \$800      |
|  | POINT OF USE FAUCET WITH GOOSE-NECK SPOUT | COLD ONLY (HANDLE ON RIGHT) | POU-GN-C    | \$570      |
|   |   | HOT ONLY (HANDLE ON LEFT)   | POU-GN-H    | \$600      |











# KITCHEN & BAR

| PHOTO   | DESCRIPTION   | PART NUMBER                              | LIST PRICE |       |
|---|---|--|------------|-------|
|     |   | STANDARD SINKS<br>WITHOUT DISPOSAL       | SF-11-252  | \$115 |
|   | <b>KITCHEN DRAINS<br/>WITH STRAINERS</b><br><br><b>FITS 3-1/2" - 4" OPENINGS</b>  | STANDARD SINKS<br>WITH ISE-TYPE DISPOSAL | SF-11-361  | \$125 |
|   |   | THICK SINKS<br>WITHOUT DISPOSAL          | SF-11-300  | \$165 |
|   |   | THICK SINKS<br>WITH ISE-TYPE DISPOSAL    | SF-11-362  | \$195 |
|     | <b>BAR SINK DRAIN<br/>WITH STRAINER</b><br><br><b>FITS 2" OPENINGS</b><br><b>1-1/2" DRAIN, 2-7/8" FACE DIAMETER</b><br><b>NO OVERFLOW</b> |  | DRAIN-BAR  | \$130 |
|   | AIR GAP KIT   |  | SF-37-001  | \$65  |
|   | AIR SWITCH AND CONTROLLER   |  | SF-37-018  | \$330 |
|  | AIR SWITCH<br>BUTTON ONLY   |  | SF-37-017  | \$125 |
|   | ROUND FAUCET HOLE COVER<br>2" DIAMETER  |  | SF-11-270  | \$30  |

# LAV & TUB DRAINS









| PHOTO   | DESCRIPTION  |     | PART NUMBER | LIST PRICE |
|---|--|-----|-------------|------------|
|    | <p>FLIP-TOP DRAIN</p> <p>1-1/4" DRAIN, 2-3/8" FACE DIAMETER WITHOUT OVERFLOW</p> <p>AVAILABLE WITH OVERFLOW BY SPECIAL ORDER</p> | LAV | DRAIN-FT    | \$150      |
|    | <p>LIFT &amp; TURN DRAIN</p> <p>LAV VERSION INCLUDES OVERFLOW (FIELD MODIFIED TO REMOVE OVERFLOW HOLES)</p>                      | LAV | DRAIN-LT    | \$130      |
|    | <p>SOFT TOUCH DRAIN WITHOUT OVERFLOW</p> <p>AVAILABLE WITH OVERFLOW BY SPECIAL ORDER</p>   | LAV | DRAIN-ST    | \$170      |
|   | <p>GRID DRAIN WITHOUT OVERFLOW</p> <p>AVAILABLE WITH OVERFLOW BY SPECIAL ORDER</p>   | LAV | DRAIN-GR    | \$170      |
|  | 1-1/4" x 12" P-TRAP WITH FLANGE  |     | DRAIN-TRAP  | \$190      |
|  | 1-1/4" x 8" DRAIN EXTENSION  |     | DRAIN-EXT   | \$110      |
|  | <p>1-1/4" x 12" EXTENDED TAILPIECE</p> <p>*FITS ONLY FLIP-TOP AND GRID DRAINS</p>  |     | DRAIN-TAIL  | \$85       |

# FLOOR DRAINS

| PHOTO   | DESCRIPTION  | PART NUMBER | LIST PRICE |
|---|--|-------------|------------|
|    | 2" ABS FLOOR DRAIN ROUGH<br>FOR 4" TOPS            | SF-2ABS     | \$110      |
|    | 2" PVC FLOOR DRAIN ROUGH<br>FOR 4" TOPS            | SF-2PVC     | \$110      |
|    | 3" ABS FLOOR DRAIN ROUGH<br>FOR 5" & 6" TOPS       | SF-3ABS     | \$110      |
|    | 3" PVC FLOOR DRAIN ROUGH<br>FOR 5" & 6" TOPS       | SF-3PVC     | \$110      |
|   | 2" CAST IRON FLOOR DRAIN ROUGH<br>FOR 5" & 6" TOPS | SF-2CI      | \$160      |
|  | 4" SQUARE DRAIN TOP                                | SF-4SQ      | \$195      |
|  | 5" SQUARE DRAIN TOP                                | SF-5SQ      | \$295      |
|  | 6" SQUARE DRAIN TOP                                | SF-6SQ      | \$340      |
|  | 4" ROUND DRAIN TOP                                 | SF-4RND     | \$345      |
|  | 6" ROUND DRAIN TOP                                 | SF-6RND     | \$385      |

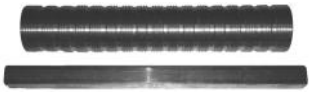

# MISCELLANEOUS / REPLACEMENT PARTS

| PHOTO   | DESCRIPTION  | PART NUMBER    | LIST PRICE |
|---|--|----------------|------------|
|    | COMPLETE SET OF STANDARD FINISH SAMPLES  | FINISH SAMPLES | \$50       |
|    | 20-POINT 1/2" CARTRIDGE FOR:<br>WATERBRIDGE, WHEREVER, CIXX,<br>AND BROWNSTONE FAUCETS   | 1/2-CART-20-H  | \$40       |
|   |  | 1/2-CART-20-C  | \$40       |
|    | 16-POINT 1/2" CARTRIDGE FOR:<br>WINGNUT, CUVÉE, AND STRAP FAUCETS  | 1/2-CART-16-H  | \$40       |
|   |  | 1/2-CART-16-C  | \$40       |
|   | 3/4" CARTRIDGE   | 3/4-CART-20-H  | \$55       |
|   |  | 3/4-CART-20-C  | \$55       |
|   | 1" STEM EXTENSION<br>FOR WHEREVER & CIXX CONTROLS  | STEM-EXT-1     | \$40       |
|  | 1-1/2" STEM EXTENSION KIT<br>FOR WHEREVER & CIXX CONTROLS<br><br>INCLUDES THREADED TUBE<br>AND VALVE STEM EXTENSIONS,<br>WITH .02 oz. TUBE OF ADHESIVE | STEM-EXT-1-1/2 | \$85       |
|  | 1-3/4" STEM EXTENSION KIT<br>FOR STRAP CONTROLS  | STEM-EXT-1-3/4 | \$45       |
|  | THERMOSTATIC VALVE STEM EXTENSION<br><br>REPLACEMENT 4-1/2" THREADED TUBE<br>AND 5" INNER SQUARE TUBE  | THERM-TUBE-EXT | \$130      |
|  | 3/4" x 12" STRAIGHT NIPPLE   | NIPPLE-3/4-12  | \$65       |
|  | PACK OF FOUR 3" WOOD SCREWS<br>WITH FINISHED HEADS   | WB-SCREWS      | \$35       |

# INDEX

| PART NUMBER      | PAGE | PART NUMBER      | PAGE | PART NUMBER        | PAGE | PART NUMBER           | PAGE |
|------------------|------|------------------|------|--------------------|------|-----------------------|------|
| 1/2-CART         | 41   | SANS-WE-WM-7     | 31   | ST-10-361          | 28   | WB-SHW-1080           | 9    |
| 3/4-CART         | 41   | SANS-WE-WM-9     | 31   | ST-ACC-RH          | 26   | WB-SHW-1140           | 11   |
| BRUT-CAP-S-FX    | 32   | SANS-WE-WM-CAP   | 31   | ST-ACC-TB          | 26   | WB-SHW-1150           | 11   |
| BRUT-CAP-SW      | 33   | SANS-WE-WM-LBO-L | 31   | ST-ACC-TP          | 26   | WB-SHW-1170           | 11   |
| BRUT-CAP-T-FX    | 32   | SANS-WE-WM-LBO-S | 31   | ST-DM-DIV          | 27   | WB-SHW-1180           | 11   |
| BRUT-CAP-W/SP    | 33   | SANS-WE-WM-WF    | 31   | STEM-EXT           | 41   | WB-SHW-840            | 8    |
| BRUT-LBO-S-FX    | 32   | SF-10-016        | 23   | ST-LAV-DM          | 26   | WB-SHW-850            | 8    |
| BRUT-LBO-SW      | 33   | SF-10-037        | 28   | ST-LAV-WM-L        | 26   | WB-SHW-870            | 8    |
| BRUT-LBO-T-FX    | 32   | SF-10-042        | 28   | ST-LAV-WM-S        | 26   | WB-SHW-880            | 8    |
| BRUT-LBO-W/SP    | 33   | SF-10-047        | 28   | ST-PB              | 27   | WB-SHW-940            | 10   |
| BRUT-PO          | 33   | SF-10-049        | 29   | ST-RTF-DM          | 26   | WB-SHW-950            | 10   |
| BRUT-PREP        | 33   | SF-10-052        | 13   | ST-RTF-WM-L        | 26   | WB-SHW-970            | 10   |
| BRUT-SP          | 33   | SF-10-052        | 20   | ST-RTF-WM-S        | 26   | WB-SHW-980            | 10   |
| BRUT-WF-S-FX     | 32   | SF-10-054        | 13   | ST-SC              | 26   | WB-SHW-ARM12          | 12   |
| BRUT-WF-T-FX     | 32   | SF-10-054        | 20   | ST-THERM           | 27   | WB-SHW-ARM18          | 12   |
| BS-DM-FX         | 36   | SF-10-060        | 13   | ST-WM-1/2VC        | 27   | WB-SHW-ARM26          | 12   |
| BS-DM-LG         | 36   | SF-10-063        | 21   | ST-WM-3/4VC        | 27   | WB-SHW-ARM45          | 12   |
| BS-DM-LG-W/SP    | 36   | SF-10-088        | 28   | ST-WM-DIV2         | 27   | WB-SHW-ARM-BRKT       | 12   |
| BS-DM-SW         | 36   | SF-10-100        | 29   | ST-WM-DIV3         | 27   | WB-SHW-BKG-PLT        | 13   |
| BS-DM-SW-W/SP    | 36   | SF-10-100        | 20   | THERM-TUBE-EXT     | 41   | WB-SHW-FTWSH-1        | 12   |
| BS-WM-FX         | 36   | SF-10-102        | 20   | WB-10-255          | 23   | WB-SHW-FTWSH-2        | 12   |
| BS-WM-LG         | 36   | SF-10-102        | 29   | WB-10-272          | 23   | WB-SHW-HNDL           | 13   |
| BS-WM-SW         | 36   | SF-10-103        | 20   | WB-10-276          | 22   | WB-WM-GN-FX           | 34   |
| CV-GN-FX         | 35   | SF-10-103        | 29   | WB-ACC-CLAMP-HS    | 7    | WB-WM-GN-LG           | 34   |
| CV-GN-LG         | 35   | SF-10-105        | 20   | WB-ACC-CLAMP-SD    | 7    | WB-WM-GN-SW           | 34   |
| CV-GN-LG-W/SP    | 35   | SF-10-106        | 20   | WB-ACC-CP10        | 15   | WB-WM-SQ-FX           | 34   |
| CV-GN-SW         | 35   | SF-10-106        | 29   | WB-ACC-CP          | 15   | WB-WM-SQ-SW           | 34   |
| CV-GN-W/SP       | 35   | SF-10-140        | 20   | WB-ACC-CP5         | 15   | WE-ACC-PLT-1          | 18   |
| CX-ACC-CP        | 24   | SF-10-140        | 29   | WB-ACC-CR          | 13   | WE-ACC-PLT-3          | 18   |
| CX-ACC-MIR       | 25   | SF-10-141        | 20   | WB-ACC-DM-PLT      | 7    | WE-DM-DIV2            | 18   |
| CX-ACC-RH        | 24   | SF-10-141        | 29   | WB-ACC-GB          | 15   | WE-DM-SC              | 18   |
| CX-ACC-TB        | 24   | SF-10-142        | 20   | WB-ACC-LEG EXT     | 7    | WE-HNDL-C             | 18   |
| CX-ACC-TP        | 24   | SF-10-142        | 29   | WB-ACC-MIR         | 14   | WE-HNDL-L             | 18   |
| CX-BODY SPRAY    | 25   | SF-10-143        | 20   | WB-ACC-RH          | 14   | WE-HNDL-T             | 18   |
| CX-DM-DIV        | 25   | SF-10-143        | 29   | WB-ACC-SD          | 14   | WE-LAV-DM-CAP-S       | 16   |
| CX-DM-SC         | 24   | SF-10-144        | 20   | WB-ACC-SD          | 21   | WE-LAV-DM-CAP-T       | 16   |
| CX-LAV-DM-S      | 24   | SF-10-144        | 29   | WB-ACC-SP-CT       | 15   | WE-LAV-DM-GN          | 16   |
| CX-LAV-DM-T      | 24   | SF-10-146        | 20   | WB-ACC-SP-DM       | 15   | WE-LAV-DM-LBO-S       | 16   |
| CX-LAV-WM        | 24   | SF-10-146        | 29   | WB-ACC-SP-WM       | 15   | WE-LAV-DM-LBO-T       | 16   |
| CX-PB            | 25   | SF-10-147        | 20   | WB-ACC-TB          | 14   | WE-LAV-DM-WF          | 16   |
| CX-RTF-DM        | 24   | SF-10-147        | 29   | WB-ACC-TEE         | 7    | WE-LAV-WM-7           | 17   |
| CX-RTF-WM        | 24   | SF-10-150        | 20   | WB-ACC-TP-1        | 14   | WE-LAV-WM-9           | 17   |
| CX-RTF-WM-SPOUT  | 25   | SF-10-151        | 20   | WB-ACC-TP-2        | 14   | WE-LAV-WM-CAP         | 17   |
| CX-SHW-HD        | 25   | SF-10-154        | 20   | WB-ACC-TWLR        | 14   | WE-LAV-WM-LBO-L       | 17   |
| CX-SHW-HNDL      | 25   | SF-10-154        | 29   | WB-ACC-WM-PLT      | 7    | WE-LAV-WM-LBO-S       | 17   |
| CX-THERM         | 25   | SF-10-156        | 20   | WB-DM-GN-FX        | 34   | WE-LAV-WM-WF          | 17   |
| CX-WM-1/2VC      | 25   | SF-10-156        | 29   | WB-DM-GN-LG        | 34   | WE-MINI-THERM         | 19   |
| CX-WM-3/4VC      | 25   | SF-10-255        | 23   | WB-DM-GN-SW        | 34   | WE-PB                 | 19   |
| CX-WM-DIV        | 25   | SF-10-272        | 23   | WB-DM-SQ-FX        | 34   | WE-RTF-DM-CAP-S       | 16   |
| CX-WM-SC         | 24   | SF-10-275        | 23   | WB-DM-SQ-SW        | 34   | WE-RTF-DM-CAP-T       | 16   |
| DRAIN-BAR        | 38   | SF-10-276        | 22   | WB-HNDL-L          | 7    | WE-RTF-DM-GN          | 16   |
| DRAIN-EXT        | 39   | SF-10-320        | 22   | WB-HNDL-T          | 7    | WE-RTF-DM-LBO-S       | 16   |
| DRAIN-FT         | 39   | SF-10-572        | 23   | WB-LAV-DM-LBO-S    | 5    | WE-RTF-DM-LBO-T       | 16   |
| DRAIN-GR         | 39   | SF-11-252        | 38   | WB-LAV-DM-LBO-T    | 5    | WE-RTF-DM-WF          | 16   |
| DRAIN-LT         | 39   | SF-11-256        | 39   | WB-LAV-DM-WF-S     | 4    | WE-RTF-WM-7           | 17   |
| DRAIN-ST         | 39   | SF-11-257        | 39   | WB-LAV-DM-WF-T     | 4    | WE-RTF-WM-7-SPOUT     | 19   |
| DRAIN-TAIL       | 39   | SF-11-269        | 39   | WB-LAV-FM-LBO      | 5    | WE-RTF-WM-9           | 17   |
| DRAIN-TRAP       | 39   | SF-11-270        | 38   | WB-LAV-FM-WF       | 4    | WE-RTF-WM-CAP         | 17   |
| FINISH SAMPLES   | 41   | SF-11-300        | 38   | WB-LAV-WM-LBO      | 5    | WE-RTF-WM-LBO-L       | 17   |
| HS-WM-SB         | 12   | SF-11-361        | 38   | WB-LAV-WM-WF       | 4    | WE-RTF-WM-LBO-S       | 17   |
| NIPPLE-3/4-12    | 41   | SF-11-362        | 38   | WB-RTDO            | 4    | WE-RTF-WM-LBO-S-SPOUT | 19   |
| POU-GN-C         | 37   | SF-2ABS          | 40   | WB-RTF-DM-LBO      | 5    | WE-RTF-WM-WF          | 17   |
| POU-GN-H         | 37   | SF-2PVC          | 40   | WB-RTF-DM-LBO-HS   | 6    | WE-RTF-WM-WF-SPOUT    | 19   |
| POU-GN-HC        | 37   | SF-37-001        | 38   | WB-RTF-DM-WF       | 4    | WE-THERM              | 19   |
| POU-LBO-C        | 37   | SF-37-017        | 38   | WB-RTF-DM-WF-HS    | 6    | WE-TRIM-RING          | 21   |
| POU-LBO-H        | 37   | SF-37-018        | 38   | WB-RTF-FM-LBO      | 5    | WE-WM-1/2VC           | 19   |
| POU-LBO-HC       | 37   | SF-3ABS          | 40   | WB-RTF-FM-LBO-CSTM | 5    | WE-WM-3/4VC           | 19   |
| SANS-AC-ADAPTER  | 31   | SF-3PVC          | 40   | WB-RTF-FM-LBO-HS   | 6    | WE-WM-DIV             | 19   |
| SANS-CX-DM-S     | 30   | SF-4RND          | 40   | WB-RTF-FM-WF       | 4    | WE-WM-SC              | 18   |
| SANS-CX-DM-T     | 30   | SF-4SQ           | 40   | WB-RTF-FM-WF-CSTM  | 4    | WN-GN-FX              | 35   |
| SANS-CX-WM       | 31   | SF-5SQ           | 40   | WB-RTF-FM-WF-HS    | 6    | WN-GN-LG              | 35   |
| SANS-ST-DM       | 30   | SF-6RND          | 40   | WB-RTF-WM-LBO      | 5    | WN-GN-LG-W/SP         | 35   |
| SANS-ST-WM       | 31   | SF-6SQ           | 40   | WB-RTF-WM-LBO-HS   | 6    | WN-GN-SW              | 35   |
| SANS-WE-DM-CAP-S | 30   | SF-CI            | 40   | WB-RTF-WM-WF       | 4    | WN-GN-W/SP            | 35   |
| SANS-WE-DM-CAP-T | 30   | SHW-WATTS        | 19   | WB-RTF-WM-WF-HS    | 6    | WN-SP                 | 35   |
| SANS-WE-DM-GN    | 30   | ST-10-105        | 28   | WB-SCREWS          | 41   | WN-SQ-FX              | 35   |
| SANS-WE-DM-LBO-S | 30   | ST-10-124        | 28   | WB-SHW-1040        | 9    | WN-SQ-SW              | 35   |
| SANS-WE-DM-LBO-T | 30   | ST-10-132        | 28   | WB-SHW-1050        | 9    | WN-SQ-W/SP            | 35   |
| SANS-WE-DM-WF    | 30   | ST-10-135        | 28   | WB-SHW-1070        | 9    |                       |      |

# SONOMA FORGE TERMS & CONDITIONS

## **PRICING**

Lav, Tub, and Shower products include rough valves and trim. Unless otherwise noted, all products are priced individually. Most lav faucet kits include one matching drain.

Shipping, handling, duties, taxes, storage, payment processing fees, etc., are not included.

## **SHIPPING**

Shipping charges are always prepaid by Sonoma Forge. "Freight Collect" and "Third Party" are not available. Products ship via ground carrier unless requested otherwise. Tracking information is listed on the invoice.

Invoices equal to or greater than \$10,000 qualify for free domestic ground shipping.

Additional charges may apply for lift gate service, excess insurance, residential delivery, inside delivery, limited access delivery, call before delivery, guaranteed delivery, weekend delivery, holiday delivery, changes in delivery, and expedited delivery. Cancelling or returning items that reduce the invoiced total to below \$10,000 will result in billing of the entire shipping charges.

## **WARRANTY**

Sonoma Forge products are assembled and finished by hand in the USA. Each part is unique and individual, and may vary slightly from one part to another. Living finishes will change over time, to degrees dependent on environment. This is natural, and these changes are not warranted.

We warrant the quality of our products to be free of manufactured defects and will repair any defective product up to two years from purchase date. Product will be replaced if not repairable, at the discretion of Sonoma Forge.

Replacement parts may not be available for discontinued products after two years of purchase.

Products installed outdoors do not qualify for complete warranty.

Damage from freezing temperatures is not covered under warranty.

Sonoma Forge shall not be responsible or held liable for labor, installation, removal, or shipping charges; consequential, incidental, indirect, special, economic, or punitive damages; as well as illness injury, disability, or death from installation or use of our products.

## **CLAIMS**

All orders must be inspected upon receipt. Damage or discrepancies must be reported to Sonoma Forge within three (3) business days of delivery, and before product leaves the original delivery address.

Packaging with visible damage should be noted with the carrier upon receipt. Packages should be refused if product damage is obvious from the outside of the packaging.

Sonoma Forge is not liable for lost or damaged product drop-shipped to a dealer's customer. The dealer takes full responsibility for any drop-shipped product after it has shipped from Sonoma Forge.

## **RETURNS & CANCELLATIONS**

No returns will be accepted without prior authorization from Sonoma Forge.

Sonoma Forge is not responsible for any labor, packaging, shipping costs or damage of returning product.

Restocking fees will be assessed based on several conditions, not limited to:

- Date of original invoice:
  - Up to 30 days: 25%
  - 31 to 60 days: 35%
  - 61 to 90 days: 50%
  - 91+ days: negotiable
- Used, damaged, and custom products are not returnable.

Order cancellations are only accepted by email, and are subject to a fee of up to 75%.

## **CARE & MAINTENANCE**

Wipe with a clean, soft, damp cloth. Mild soap may be used. Blot dry.

100% carnauba wax can be used properly to protect finishes.

For information or parts not listed in our price book, please contact Sonoma Forge.

